

HEADER-DIP2x25-254-Male
HEADER-DIP2x25-254-Male-BOT

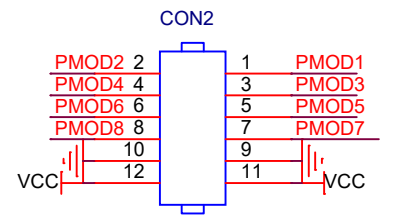

HEADER-DIP2x6-254-FEMALE
HEADER-DIP2x6-254-FEMALE-TOP

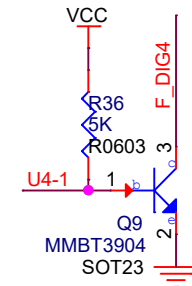
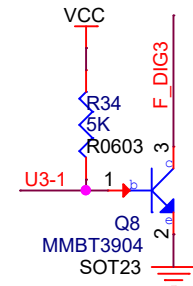
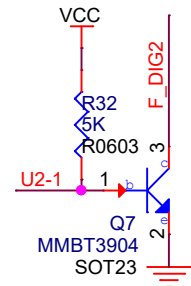
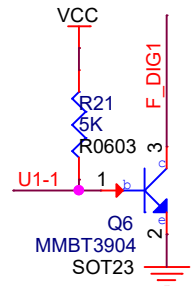
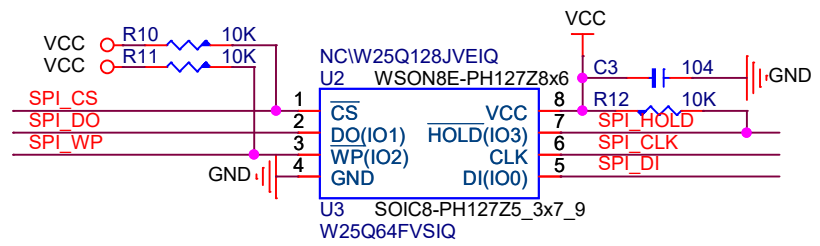
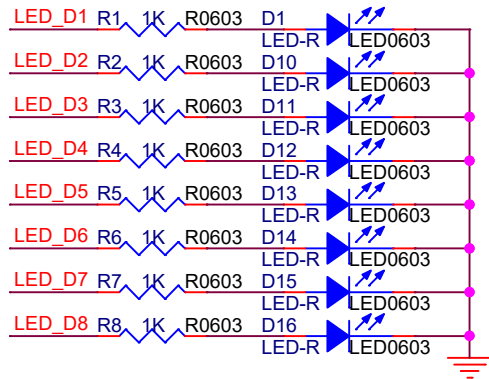
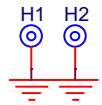
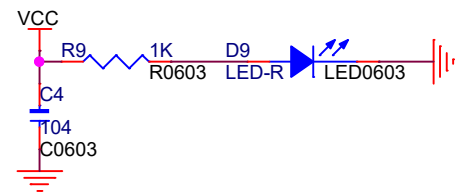
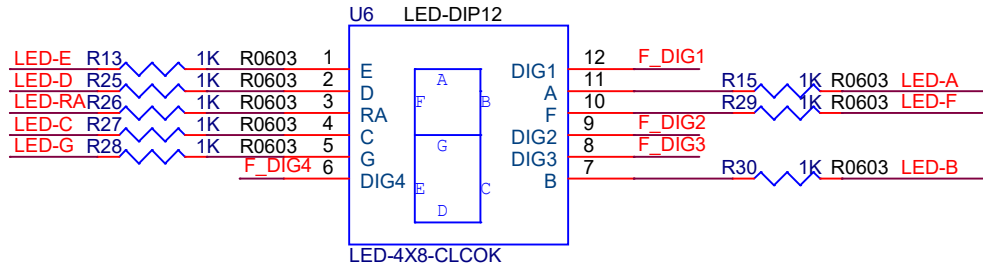

GUANGDONG BIPAI KEJI CPA.LTD

Design Name

SP7021-SUBBOARD

Size	Page Name	Rev
A	SUBBOARD	V00

Date: Monday, March 23, 2020 Sheet 1 of 2

5

4

3

2

1

D

D

C

C

B

B

A

A



Title <Title>		
Size A	Document Number <Doc>	Rev <RevCode>
Date:	Monday, March 23, 2020	Sheet 2 of 2

5

4

3

2

1